

YAMAHA CDX-450

Natural Sound Compact Disc Player

Random Access Programmable Play

Random-Sequence Play

Multi-Mode Repeat Play

Automatic Tape-Programming

Remote Control Capability

Thank you for selecting the YAMAHA Compact Disc Player.

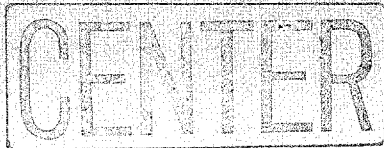

OWNER'S MANUAL

CONTENTS

Safety Instructions	2
Caution	2
Warning	3
Connections	4
Identification of Components	5
Loading the Disc/Disc Play	6
Random-sequence Play	9
Repeat Play	9
Program Play	10
Index Search	11
Track Programming for Recording to Tape	12
Notes about the Remote Control Transmitter	15
Notes about Handling Compact Discs	15
Troubleshooting	16
Specifications	16

IMPORTANT!

Please make a note of the serial number of this unit in the space indicated below.

Model:
Serial No.:

The serial number is inscribed on the rear of the unit.
Keep this Owner's Manual in a safe place for future reference.

WARNING

To reduce the risk of fire or electric shock, do not expose this appliance to rain or moisture.



• Explanation of Graphical Symbols



The lightning flash with arrowhead symbol, within an equilateral triangle, is intended to alert you to the presence of uninsulated "dangerous voltage" within the product's enclosure that may be of sufficient magnitude to constitute a risk of electric shock to persons.



The exclamation point within an equilateral triangle is intended to alert you to the presence of important operating and maintenance (servicing) instructions in the literature accompanying the appliance.

SAFETY INSTRUCTIONS

- 1 Read Instructions – All the safety and operating instructions should be read before the appliance is operated.
- 2 Retain Instructions – The safety and operating instructions should be retained for future reference.
- 3 Heed Warnings – All warnings on the appliance and in the operating instructions should be adhered to.
- 4 Follow Instructions – All operating and other instructions should be followed.
- 5 Water and Moisture – The appliance should not be used near water – for example, near a bathtub, washbowl, kitchen sink, laundry tub, in a wet basement, or near a swimming pool, etc.
- 6 Carts and Stands – The appliance should be used only with a cart or stand that is recommended by the manufacturer.
- 6A An appliance and cart combination should be moved with care. Quick stops, excessive force, and uneven surfaces may cause the appliance and cart combination to overturn.
- 7 Wall or Ceiling Mounting – The appliance should be mounted to a wall or ceiling only as recommended by the manufacturer.
- 8 Ventilation – The appliance should be situated so that its location or position does not interfere with its proper ventilation. For example, the appliance should not be situated on a bed, sofa, rug, or similar surface, that may block the ventilation openings; or placed in a built-in installation, such as a bookcase or cabinet that may impede the flow of air through the ventilation openings.
- 9 Heat – The appliance should be situated away from heat sources such as radiators, stoves, or other appliances that produce heat.



- 10 Power Sources – The appliance should be connected to a power supply only of the type described in the operating instructions or as marked on the appliance.
- 11 Power-Cord Protection – Power-supply cords should be routed so that they are not likely to be walked on or pinched by items placed upon or against them, paying particular attention to cords at plugs, convenience receptacles, and the point where they exit from the appliance.
- 12 Cleaning – The appliance should be cleaned only as recommended by the manufacturer.
- 13 Nonuse Periods – The power cord of the appliance should be unplugged from the outlet when left unused for a long period of time.
- 14 Object and Liquid Entry – Care should be taken so that objects do not fall into and liquids are not spilled into the inside of the appliance.
- 15 Damage Requiring Service – The appliance should be serviced by qualified service personnel when:
 - A. The power-supply cord or the plug has been damaged; or
 - B. Objects have fallen, or liquid has been spilled into the appliance; or
 - C. The appliance has been exposed to rain; or
 - D. The appliance does not appear to operate normally or exhibits a marked change in performance; or
 - E. The appliance has been dropped, or the cabinet damaged.
- 16 Servicing – The user should not attempt to service the appliance beyond those means described in the operating instructions. All other servicing should be referred to qualified service personnel.
- 17 Power Lines – An outdoor antenna should be located away from power lines.
- 18 Grounding or Polarization – The precautions that should be taken so that the grounding or polarization is not defeated.

CAUTION: READ THIS BEFORE OPERATING YOUR UNIT

- 1 To ensure the finest performance, please read this manual carefully. Keep it in a safe place for future reference.
- 2 Install your unit in a cool, dry, clean place – away from windows, heat sources, and too much vibration, dust, moisture or cold. Avoid sources of hum (transformers, motors). To prevent fire or electrical shock, do not expose to rain and water.
- 3 Do not operate the unit upside-down. It may overheat, possibly causing damage.
- 4 Never open the cabinet. If a foreign object drops into the set, contact your dealer.
- 5 Do not place records or other objects on top of the unit; this will block the ventilation holes, cause the internal temperature to rise and may result in a failure.
- 6 Do not use force on switches, knobs or cords. When moving the set, first turn the unit off. Then gently disconnect the power plug and the cords connecting to other equipment. Never pull the cord itself.
- 7 Do not attempt to clean the unit with chemical solvents; this might damage the finish. Use a clean, dry cloth.
- 8 Be sure to read the “Troubleshooting” section on common operating errors before concluding that your unit is faulty.

WARNING

DANGER

Invisible laser radiation when open and interlock failed or defeated.
Avoid direct exposure to beam.

CAUTION

Use of controls or adjustments or performance of procedures other than those specified herein may result in hazardous radiation exposure.

As the laser beam used in this compact disc player is harmful to the eyes, do not attempt to disassemble the cabinet. Refer servicing to qualified personnel only.

To avoid electrical shock, do not open the unit. Refer servicing to qualified personnel only.

DANGER: The use of optical instrument with this product will increase eye hazard.

FCC INFORMATION (U.S.A.)

1. IMPORTANT NOTICE : DO NOT MODIFY THIS UNIT!

This product, when installed as indicated in the instructions contained in this manual, meets FCC requirements. Modifications not expressly approved by Yamaha may void your authority, granted by the FCC, to use the product.

2. IMPORTANT : When connecting this product to accessories and/or another product use only high quality shielded cables. Cable/s supplied with this product **MUST** be used. Follow all installation instructions. Failure to follow instructions could void your FCC authorization to use this product in the USA.

3. NOTE : This product has been tested and found to comply with the requirements listed in FCC Regulations, Part 15 for Class "B" digital devices. Compliance with these requirements provides a reasonable level of assurance that your use of this product in a residential environment will not result in harmful interference with other electronic devices. This equipment generates/uses radio frequencies and, if not installed and used according to the instructions found in the users manual, may cause interference harmful to the operation of other electronic devices. Compliance with FCC regulations does not guarantee that interference will not occur in all installations. If this product is found to be the source of interference, which can be determined by turning the unit "OFF" and "ON", please try to eliminate the problem by using one of the following measures:

Relocate either this product or the device that is being affected by the interference.

Utilize power outlets that are on different branch (circuit breaker or fuse) circuits or install AC line filter/s.

In the case of radio or TV interference, relocate/reorient the antenna. If the antenna lead-in is 300 ohm ribbon lead, change the lead-in to coaxial type cable.

If these corrective measures do not produce satisfactory results, please contact the local retailer authorized to distribute this type of product. If you can not locate the appropriate retailer, please contact Yamaha Electronics Corp., U.S.A. 6722 Orangethorpe Ave, Buena Park, CA 90620.

The above statements apply **ONLY** to those products distributed by Yamaha Corporation of America or its subsidiaries.

WARNING: CHEMICAL CONTENT NOTICE!

The solder used in the manufacture of this product contains LEAD. In addition, the electrical/electronic and/or plastic (where applicable) components may also contain traces of chemicals found by the California Health and Welfare Agency (and possibly other entities) to cause cancer and/or birth defects or other reproductive harm.

DO NOT REMOVE ANY ENCLOSURE COMPONENTS!

There are no user serviceable parts inside. All service should be performed by a service representative authorized by Yamaha to perform such service.

IMPORTANT MESSAGE: Yamaha strives to produce products that are both user safe and environmentally "friendly". We sincerely believe that our products meet these goals. However, in keeping with both the spirit and the letter of various statutes we have included the preceding messages and others in various locations in this manual.

CONNECTIONS

- Before making any connections, switch OFF the power to the unit and the amplifier or other component.
- Connect the "LINE OUT" terminals to the "CD" (or "AUX") terminals of the amplifier. If the amplifier does not have such terminals, use the "TAPE PB" terminals. For additional details concerning these connections, refer to the operation instructions for the amplifier being used.
- Be sure that the connection from the left ("L") LINE OUT analog output terminal and from the right ("R") terminal are to the correct corresponding (left and right) terminals of the amplifier or other component.
- If the placement of this unit causes noise to other equipment, such as a tuner, use them farther away from each other.

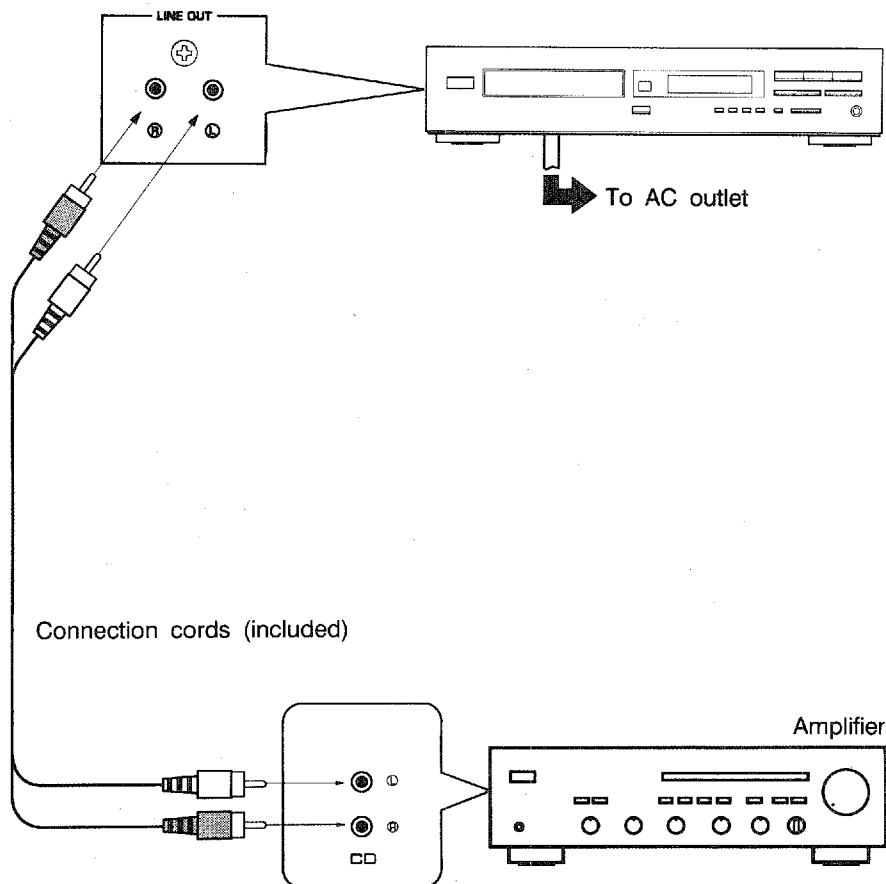

IDENTIFICATION OF COMPONENTS

FRONT PANEL

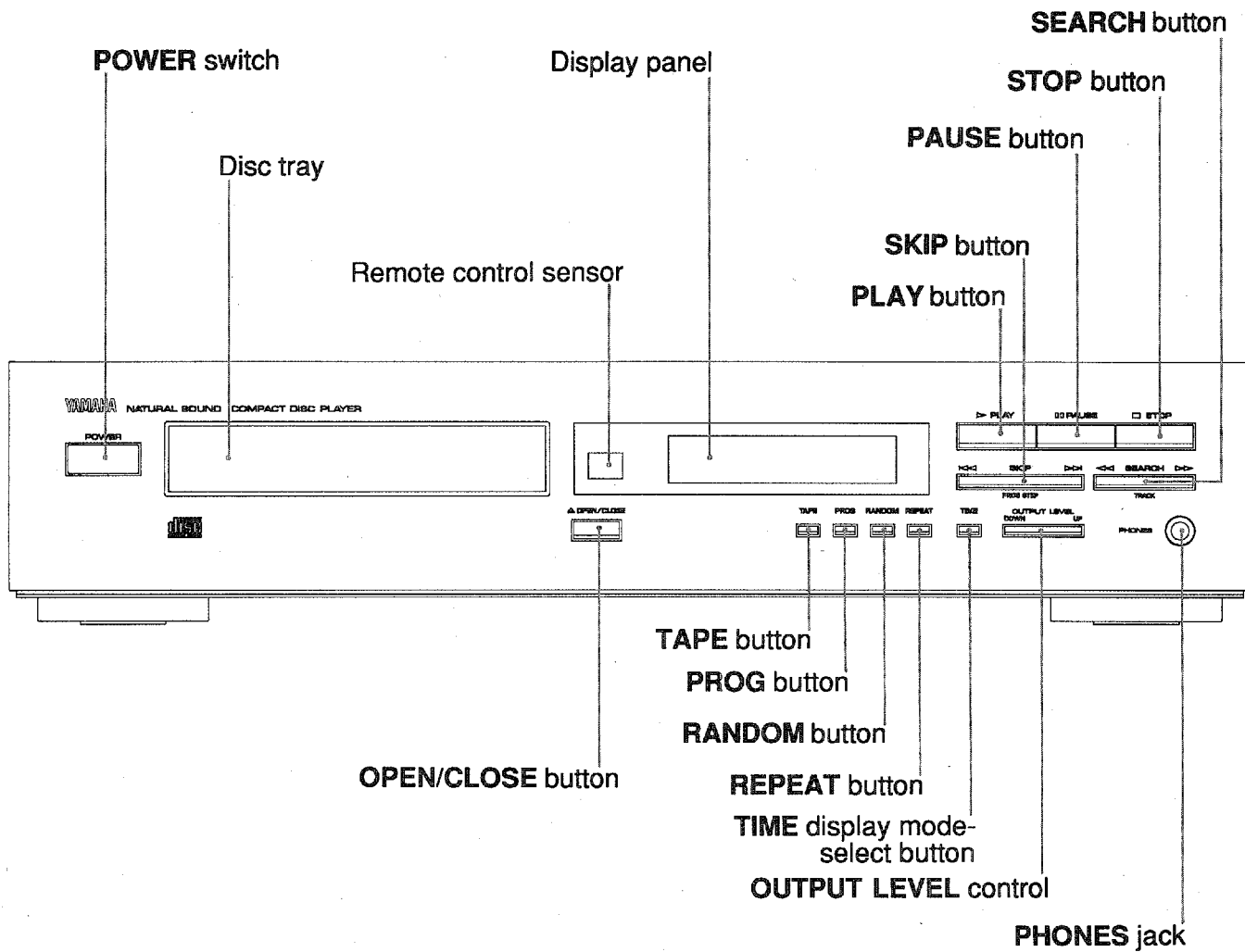

REMOTE CONTROL TRANSMITTER

* The control functions on the main unit and on the remote-control transmitter are virtually identical, with the exceptions described below.

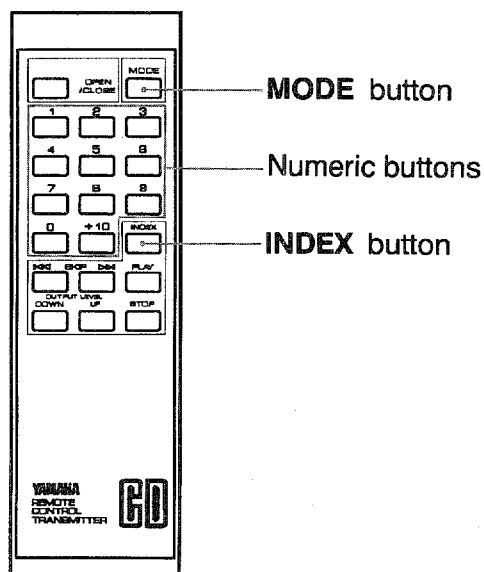

LOADING THE DISC/DISC PLAY

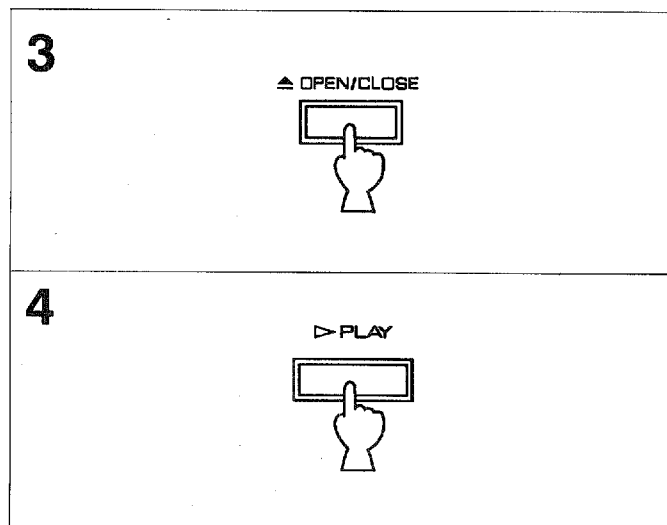
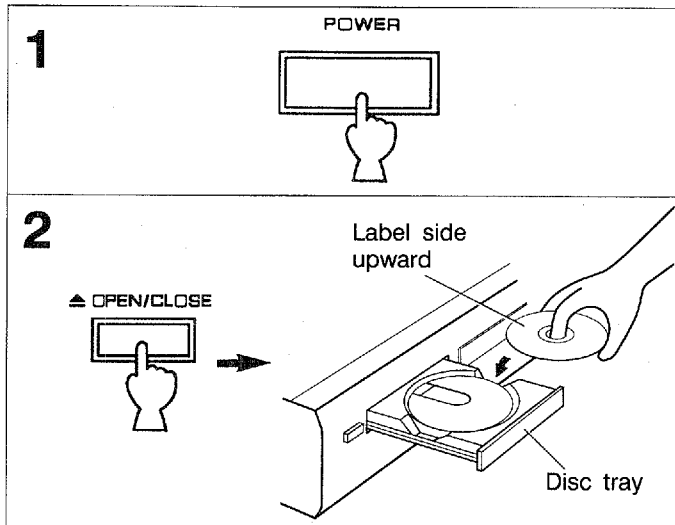
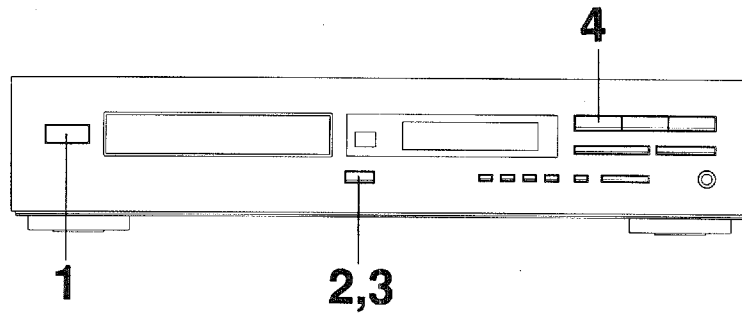

Display information at disc play

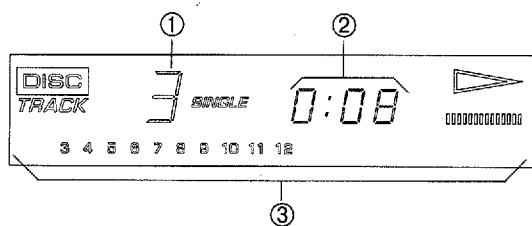

- ① Shows the track number to be played.
- ② Shows the time displays. (Refer to "Selecting time displays" on page 8.)
- ③ Displays the numbers that correspond to the numbers of the tracks (as high as number 20) on the disc. After each track is played, its corresponding number disappears so the number of remaining tracks (and their numbers) can be seen at a glance.

Notes

- After closing the disc tray by pressing the **OPEN/CLOSE** button, the display shows the total number of tracks and the total recorded time of the disc for a few seconds.

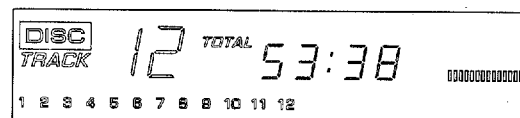

- Additionally, you can close the disc tray by pressing the **PLAY** button, a numeric button on the remote-control transmitter or the **RANDOM** button, or by pressing the front edge of the disc tray gently. If the tray is closed in these ways, play will begin automatically, however, the display will not show the total number of tracks and the total recorded time of the disc.

To stop play temporarily

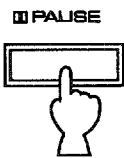

* To resume play, press the **PAUSE** button again or press the **PLAY** button.

To stop play completely

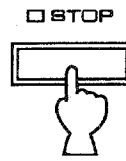

To play a desired track on the disc

DIRECT PLAY

Select a desired track by using the numeric buttons on the remote control transmitter.

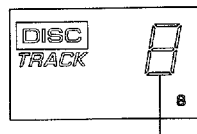
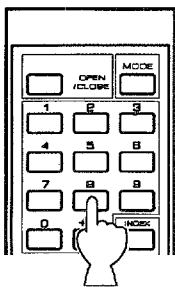

The selected track number is displayed.

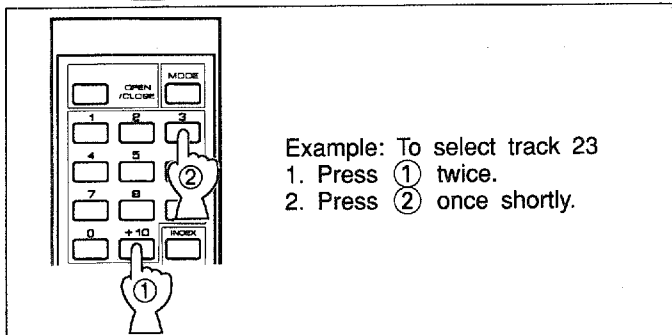

Example: To select track 23
 1. Press ① twice.
 2. Press ② once shortly.

* If a track number higher than the highest track number on the disc is selected, the last track on the disc will be played.

SKIP PLAY

• To play from the beginning of the track following the one now playing

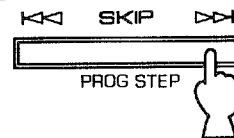

• To play from the beginning of the track now playing

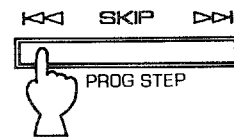

• To play from the beginning of the track before the one now playing

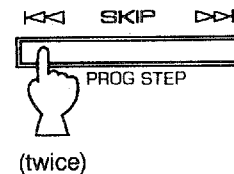

* This operation can be activated even if the unit is in the pause or stop mode.

When you listen with headphones

Connect the headphones to the **PHONES** jack and adjust the volume by using the **OUTPUT LEVEL** control. At that time, note that this adjustment will also vary the signal level output to the amplifier.

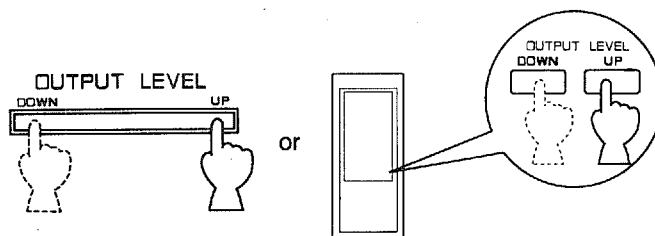
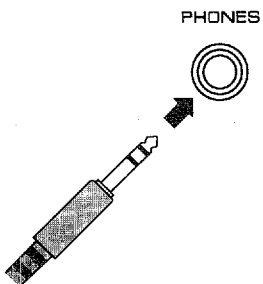

To advance or reverse play rapidly (MANUAL SEARCH)

To advance rapidly

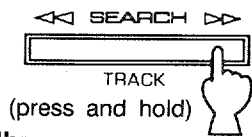

To reverse rapidly

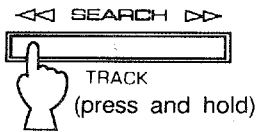

- The sound can be heard (although slightly garbled) during manual search in either direction. This is convenient for locating a precise position within a track, or for reviewing the contents quickly.
- When manual search in either direction is initiated during the pause mode, the action is the same, but no sound is heard.

Selecting time displays

You can select any of the four types of time displays by pressing the **TIME** display mode-select button.

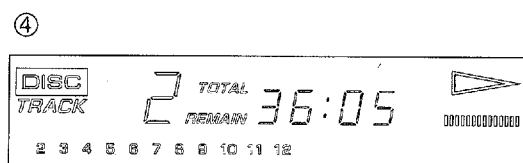
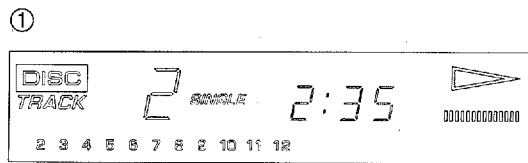

TIME

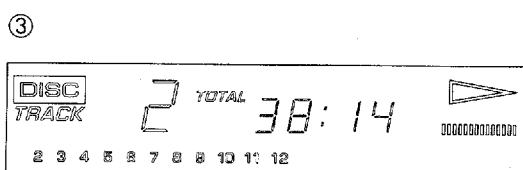
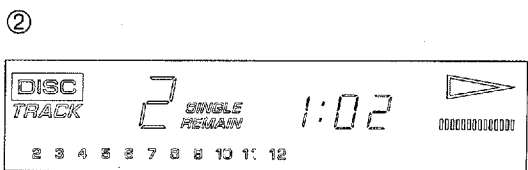

- ① Elapsed time of the track now playing
- ② Remaining time of the track now playing
- ③ Total disc play time
- ④ Total remaining time on the disc

Notes

- The remaining time ② will not be displayed for track number 25 or higher.
- If desired, you can change brightness of the display in three degrees by pressing the **MODE** button.

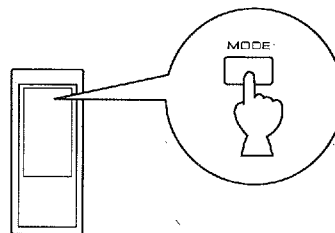

RANDOM-SEQUENCE PLAY

You can have tracks on the disc played in a random sequence selected by the unit's microcomputer.

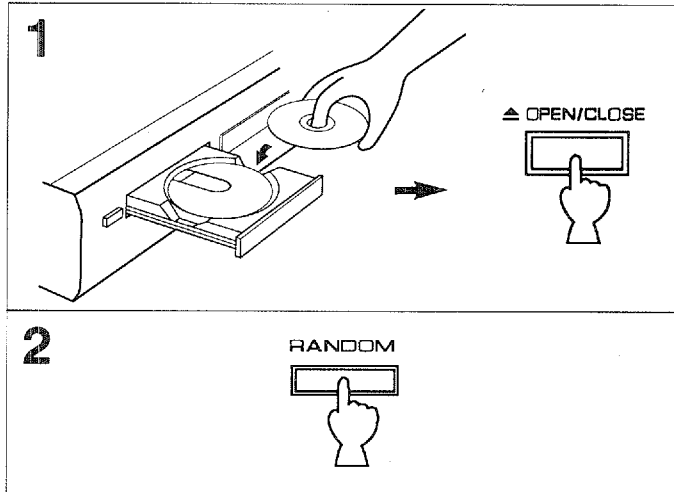
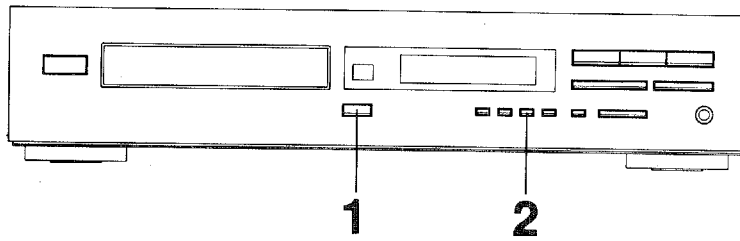

To cancel random-sequence play

Press the **STOP** button or **RANDOM** button once again, or open the disc tray by pressing the **OPEN/CLOSE** button.

Notes

- This feature will not function during programming, or during programmed play.
- If the **SKIP** >> button is pressed during random-sequence play, the next randomly programmed track will be played. If the **SKIP** << button is pressed, play will return to the beginning of the track now being played.
-  This indication appears while the unit is mixing up tracks.
- Total remaining time on the disc will not be displayed during random-sequence play.

REPEAT PLAY

You can play any desired track or the entire disc repeatedly by pressing the **REPEAT** button. The repeat-play mode will change whenever you press the **REPEAT** button.

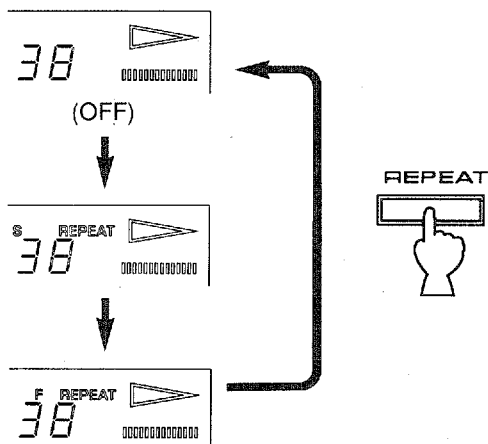

SINGLE REPEAT (S)

Only a designated track is played repeatedly.

FULL REPEAT (F)

All tracks (the entire disc) are played repeatedly.

* In the programmed-play mode, all programmed tracks are played repeatedly.

Notes

- Repeat play mode can be set in both the play mode and stop mode.
- Repeat play is also possible during the random-sequence play mode.

PROGRAM PLAY

MANUALLY PROGRAMMED PLAY

You can enjoy listening to your favorite tracks in any desired order by a programmed play. As many as 25 tracks can be programmed for a disc.

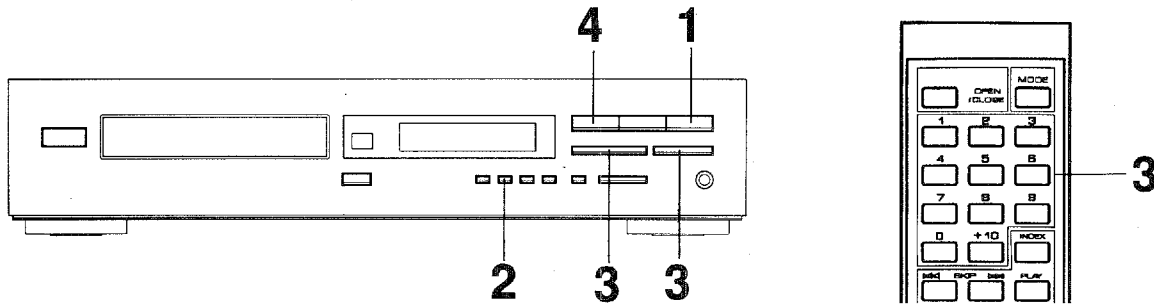

1 Set the unit in the stop mode.

STOP

2

PROG

3 Select the desired track.

* Repeat step 3 to set more programs. You can select the same track again and again.

4

PLAY

Display information at program play

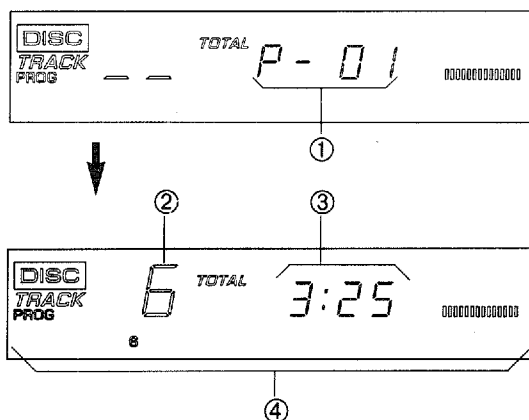

- ① Shows the program number next to be set.
- ② Shows the selected track number.
- ③ Shows the total time of the tracks programmed until now.
- ④ Shows only the numbers of programmed tracks.

* If the total time exceeds 99 minutes and 59 seconds, the time will not be displayed.

Notes

- In step 2, if "P-01" does not appear in the display, press the **TIME** display mode-select button.
- If, during program setting, the **TIME** display mode-select button is pressed, the program number display can be changed to a display of the total time of the programmed tracks. To return to the previous display, press the **TIME** display mode-select button once again.
- The **SKIP** (◀◀ and ▶▶) button can be used, but only within the range of the programmed tracks.
- The **SEARCH** (◀◀ and ▶▶) button can be used for search throughout all tracks, including unprogrammed tracks.
- The **PAUSE** mode can also be programmed (one time only), if so desired, by pressing the **PAUSE** button instead of a numeric button. (In this case, "O.OB" is illuminated in the display.)
- If, for a compact disc with 25 tracks or more, track number 25 or higher is programmed, the total time will not be displayed correctly.

To stop program play

Press the **STOP** button. The first track number programmed will be displayed.
To resume play, press the **PLAY** button. Play begins from the beginning of the program.

To cancel a programmed setting

There are several methods, as described below.

- Press the **STOP** button (after programming is completed, or while the unit is in the stop mode).
- Open the disc tray.
- Switch off the power.

To check programmed data

1. If the unit is in the play mode, press the **STOP** button.
2. Press the **PROG** button.
3. Each time the **SKIP** $\triangleright\triangleleft$ button is then pressed, the track numbers and sequential order of the programmed tracks can be checked one after another. The display of the track number can be returned (sequentially in reverse order) by pressing the **SKIP** $\triangleleft\triangleright$ button.

To correct programmed data

1. Follow the procedures in "To check programmed data".
2. Display the track number to be corrected by pressing the **SKIP** button.
3. Press a numeric button on the remote control transmitter to select a track to replace the displayed one. The previously programmed track will be cleared (from the memory) and the new one will be programmed. (You can also select a track using the **SEARCH** button on the front panel of the main unit instead of the numeric buttons.)
4. After the correction has been completed, once again press the **PROG** button.

INDEX SEARCH

If the disc includes index numbers, play can be started from any desired index number.

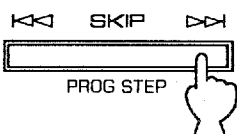
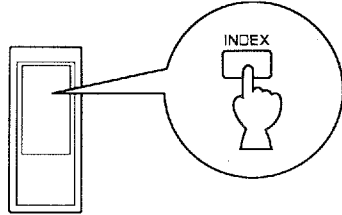
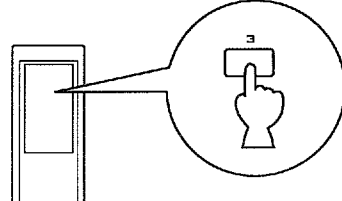
1	In the pause or stop mode, select a track which has index numbers. 
2	
3	Select the desired index number. 

To cancel the index search function

Press the **INDEX** button.

Notes

- Some discs have index numbers, and some do not. The index system is a method for sub-dividing tracks into smaller divisions (such as, for example, the movements within classical symphonies) for easier location of those parts. The liner notes with the disc usually tell if such index numbers are included.
- If an index number is selected that is higher than any index number on that disc, play will start from the last index number point on the disc.
- For some discs, play may begin slightly prior to the actual designated index point.
- If the disc has no encoded index points, play will begin from the start of the track selected by using the **SKIP** button.
- The index number can be designated only while the **INDEX** number display is illuminated.

TRACK PROGRAMMING FOR RECORDING TO TAPE

This feature can be conveniently used to program tracks on a disc for recording to tape. By only memorizing the tape's total possible recording time, the unit will automatically program tracks or help you to program tracks so they will fit onto the tape with the least amount of unrecorded space remaining at each end of the tape.

Automatic tape-programming

This is useful for recording a disc onto tape with the order of tracks unchanged.

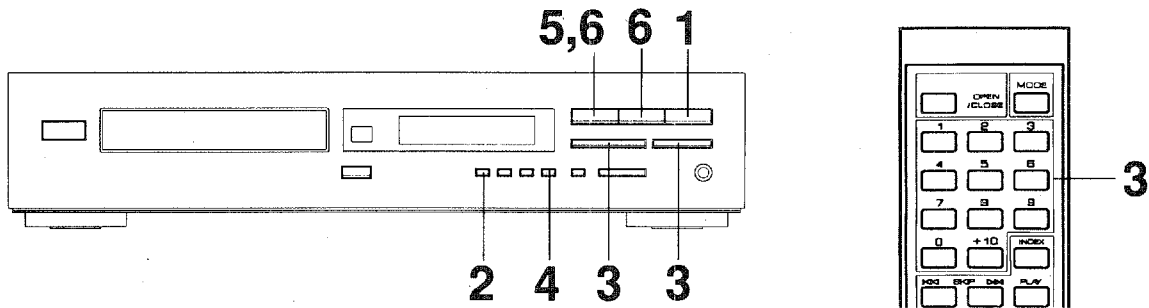

1 Set the unit in the stop mode.

2 Enter the tape's total possible recording time.

You can select any of four types of tape's length by pressing the **TAPE** button.

3 Otherwise, you can also enter the tape's total possible recording time manually.

Example:
For a C-64 tape (32 minutes on each side)

4

* By pressing the **REPEAT** button, the unit automatically programs tracks for side A and side B separately considering the tape's total time.

5 Begin recording on the tape deck and at the same time press the **PLAY** button on this unit.

6 When this unit (at the end of side A of the tape) changes to the pause mode, turn the tape over (to side B). Resume the recording and, at the same time, press the **PLAY** button or the **PAUSE** button on this unit.

- Notes**
- All tracks may not be programmed if the tape's length is not enough. To program all tracks, use a longer tape.
 - In step 5, you can check the program data for side A and side B separately for a moment.

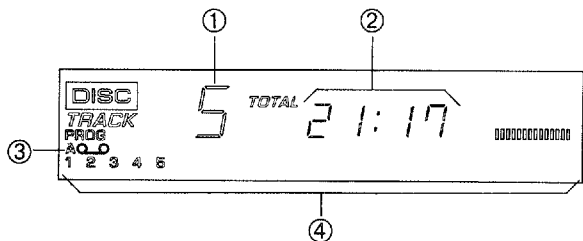

- ① Shows the number of programmed tracks.
- ② Shows the total time of programmed tracks.
- ③ Shows the side of the tape.
- ④ Shows the programmed track numbers.

Manual tape-programming

This is useful for recording desired tracks in any desired order onto tape.

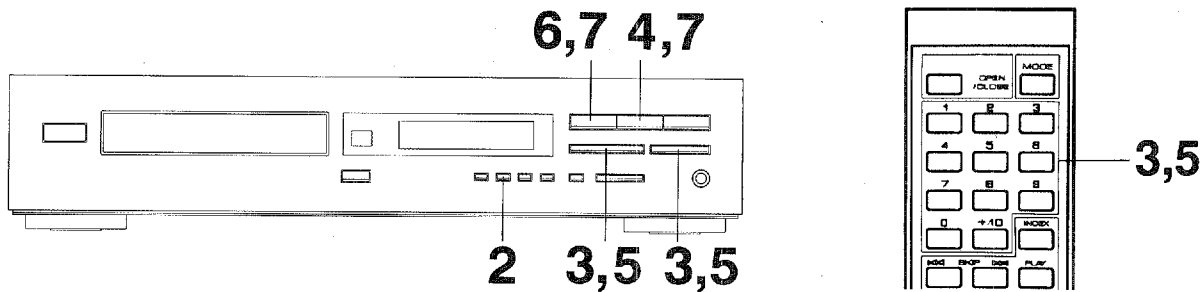

1 Follow steps 1 – 3 on page 12.

2 **PROG**

3 Select track numbers (to be recorded for side A) in the desired order.

* Programmed track numbers are illuminated on the display. You can select a track which can be programmed for the remaining time of (the side of) the tape from track numbers flashing on the display, but you cannot select any darkened track number.

4 Program a pause mode.

5 Select track numbers (to be recorded for side B) in the desired order.

6 Begin recording on the tape deck and at the same time press the **PLAY** button on this unit.

7 When this unit (at the end of side A of the tape) changes to the pause mode, turn the tape over (to side B). Resume the recording and, at the same time, press the **PLAY** button or the **PAUSE** button on this unit.

Notes

- If, in step 3 or 5, "E rr" appears in the display, the track number just selected cannot be programmed because there is not enough time remaining on the tape. However, at this time, if any other track number is flashing continuously in the display, you can program it instead of the unprogrammable one.
- In step 3 or 5, each time a selection is made, the track number and the tape's remaining time will be displayed, and then the display will change to indicate the number of the next program.
- In step 3 and 5, you can also select track numbers on the front panel. (Select a track number by the **SEARCH** button and next, set the number as a program by pressing the right side of the **SKIP** <> button. Repeat these steps to set more programs.) In this case, however, the display information is somewhat different from mentioned above.

Notes on tape-programming

- To check, cancel or correct program data, refer to page 11.
- * In checking the program data, note that "Pu" appears between track numbers for side A and side B.

- The maximum number of tracks that can be programmed is 25 (P-01 to P-25). If, however, the PAUSE mode is inserted, it is counted as one track.

■ Random sequential tape-programming

The unit will automatically program tracks in random sequential order for recording to tape.

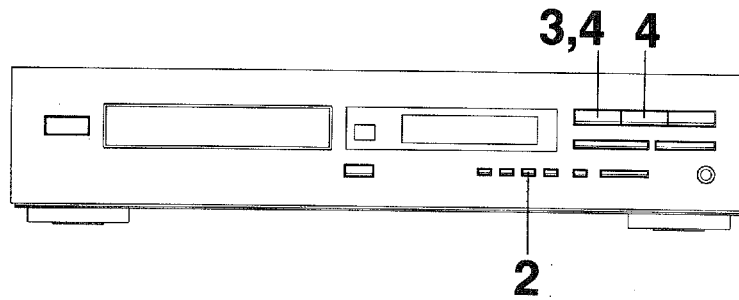

1	Follow steps 1 – 3 on page 12.
2	<div style="text-align: center;"> <p>RANDOM</p> </div> <p>* The unit automatically programs tracks for side A and side B separately by considering the tape's total time.</p>
3	Begin recording on the tape deck and at the same time press the PLAY button on this unit.
4	When this unit (at the end of side A of the tape) changes to the pause mode, turn the tape over (to side B). Resume the recording and, at the same time, press the PLAY button or the PAUSE button on this unit.

Notes

- Because the programmed data changes every time the **RANDOM** button is pressed, the amount of time remaining at the end of the tape also change accordingly.
- If the tape's length is not enough, all tracks cannot be programmed. In this case, exchange the tape for a longer one.
- In step 2, you can check the program data for side A and side B separately for a moment.

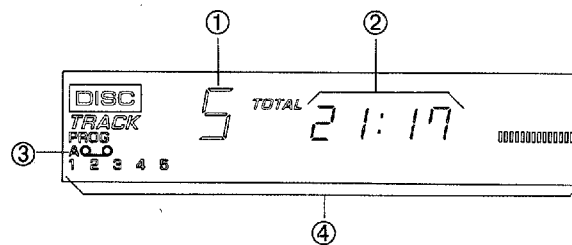

- ① Shows the number of programmed tracks.
- ② Shows the total time of programmed tracks.
- ③ Shows the side of the tape.
- ④ Shows the programmed track numbers.

NOTES ABOUT THE REMOTE CONTROL TRANSMITTER

Battery installation

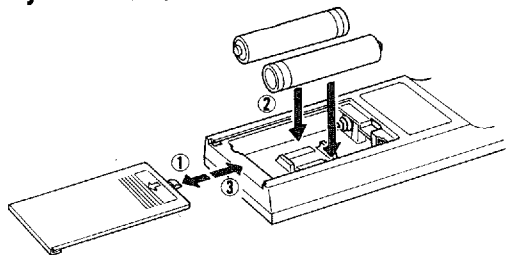

Battery replacement

If the remote-control transmitter must be used closer to the main unit, the batteries are weak. Replace both batteries with new ones.

Notes

- Use only "AAA" (R03) batteries for replacement.
- Be sure the polarities are correct. (See the illustration inside the battery compartment.)
- Remove the batteries if the remote-control transmitter will not be used for an extended period of time.
- If batteries leak, immediately dispose of them. Avoid touching the leaked material or letting it come in contact with clothing, etc. Clean the battery compartment thoroughly before installing new batteries.

Remote-control transmitter operation range

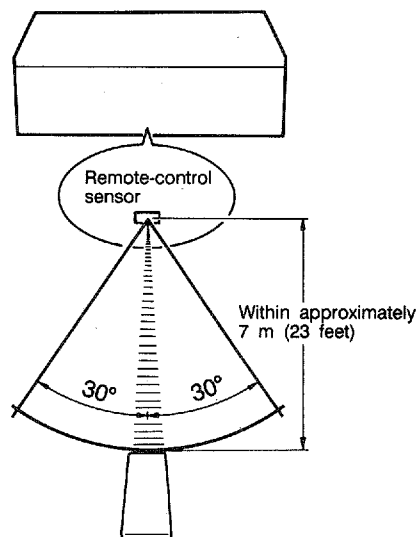

Notes

- There should be no large obstacles between the remote-control transmitter and the main unit.
- If the remote control sensor is struck by strong lighting (of an inverter type of fluorescent lamp etc.), it may happen that the remote-control transmitter does not work correctly. In this case, change the position of the main unit to avoid being lit directly.

NOTES ABOUT HANDLING COMPACT DISCS

- This compact-disc player is designed only for reproduction of compact discs bearing the  mark. Never attempt to load any other type of disc into the unit. The unit will also play 3-inch (8-cm) compact discs.
- To remove a disc from its storage case, open the case and then press down at the center; with a finger through the center hole and the outer edges held as shown in the illustration, lift the disc out carefully.

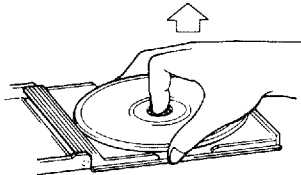

- Always handle the disc with care so that its surface is not scratched.

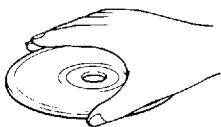

- Compact discs are not subjected to wear during play, but damage to the disc surface when the disc is being handled can adversely affect the disc's play.

- Compact discs are not affected by small particles of dust or fingerprints on their playing surface, but even so they should be kept clean. Wipe by using a clean, dry cloth. Do not wipe with a circular motion; wipe straight outward from the center.

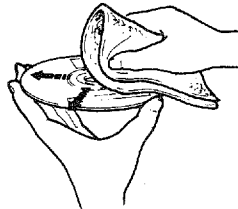

- Do not try to clean the disc's surface by using any type of disc cleaner, record spray, anti-static spray or liquid, or any other chemical-based liquid, because such substances might irreparably damage the disc's surface.
- Do not expose discs to direct sunlight, high temperature or high humidity for a long period of time, because these might warp or otherwise damage the disc.



To play a 3-inch (8-cm) CD

Place it in the inner recessed area of the disc tray. Do not put a normal (5-inch/12-cm) CD on top of a 3-inch CD.

TROUBLESHOOTING

If the unit fails to operate normally, check the following points to determine whether the problem can be corrected by the simple measures suggested. If it cannot, or if the problem is not listed in the SYMPTOM column, disconnect the unit's power cord and contact your dealer or service center for assistance.

SYMPTOM	PROBABLE CAUSE	REMEDY
The player does not switch ON when the POWER switch is pressed.	The power cord is not connected or not completely connected.	Securely connect the power cord.
The disc tray does not close completely.	A foreign object is obstructing the tray.	Carefully check the disc tray and remove the foreign object.
The DISC indicator does not illuminate.	The disc has been loaded upside down.	Load the disc correctly.
	The disc is damaged.	Check the disc carefully; replace it if necessary.
	There is moisture on the laser pickup.	Wait 20 to 30 minutes after switching the unit ON before trying to play a disc.
Play does not begin.	The disc has been loaded upside down.	Reload the disc with the label side up.
	The disc is dirty.	Clean the disc.
Play is delayed, or begins at the wrong place.	The disc may be scratched or damaged.	Check the disc carefully; replace it if necessary.
No sound.	Improper output cable connections.	Connect the cables properly. If the problem persists, the cables may be defective.
	Improper amplifier operation.	Set the amplifier controls to the correct input selection.
Sound "skips".	The player is being subjected to vibrations or impacts.	Relocate the player.
	The disc is dirty.	Clean the disc.
Sound "hums".	Improper cable connections.	Securely connect the audio cables. If the problem persists, the cables may be defective.
Noise from a nearby tuner.	The tuner is too close to the player.	Move the tuner and player farther apart.
Noise from within the disc tray.	The disc may be warped.	Replace the disc.
The remote-control transmitter does not work.	Direct sunlight or lighting (of an inverter type of fluorescent lamp etc.) is striking the remote control sensor of the main unit.	Change position of the main unit.

SPECIFICATIONS

AUDIO SECTION

Frequency response 2 Hz - 20 kHz, +0.5 dB
 -1.0 dB
 De-emphasis equalization ±0.3 dB
 Harmonic distortion+noise 0.0038% (1 kHz)
 S/N ratio 105 dB
 Dynamic range 98 dB
 Wow & flutter Unmeasurable
 Output voltage
 VARIABLE 2.0V max.
 Headphones output (-20 dB) 200 mV/150 ohms

GENERAL

Power requirements
 U.S.A. and Canada models 120V, 60 Hz
 Australia and U.K. models 240V, 50 Hz
 Europe model 230V, 50 Hz
 General model 110/120/220/240V, 50/60 Hz
 Power consumption 20W
 Dimensions (W x H x D) 435 x 92.5 x 267 mm
 (17-1/8" x 3-5/8" x 10-1/2")
 Weight 3.6 kg (7 lbs. 15 oz.)
 Accessories Connection cord
 Remote control transmitter
 Batteries (size "AAA", R03)

Please note that all specifications are subject to change without notice.

YAMAHA ELECTRONICS CORPORATION, USA 6722 ORANGETHORPE AVE., BUENA PARK, CALIF. 90620, U.S.A.
 YAMAHA CANADA MUSIC LTD. 135 MILNER AVE., SCARBOROUGH, ONTARIO M1S 3R1, CANADA
 YAMAHA ELECTRONIK EUROPA G.m.b.H. SIEMENSSTR. 22-34, D-2084 RELLINGEN BEI HAMBURG, F.R. OF GERMANY
 YAMAHA ELECTRONIQUE FRANCE S.A. 17 RUE DES CAMPANULES, LOGNES 77321 MARNE LA VALLEE CEDEX 2, FRANCE
 YAMAHA ELECTRONICS (UK) LTD. YAMAHA HOUSE, 200 RICKMANSWORTH ROAD WATFORD, HERTS WD1 7JS, ENGLAND
 YAMAHA SCANDINAVIA A.B. J A WETTERGRENS GATA 1, BOX 30053, 400 43 VÄSTRA FRÖLUNDA, SWEDEN
 YAMAHA MUSIC AUSTRALIA PTY, LTD. 17-33 MARKET ST., SOUTH MELBOURNE, 3205 VIC., AUSTRALIA

YAMAHA
 YAMAHA CORPORATION

VK62780-0 Printed in Japan BWB, G®